

INSTALLATION GUIDE

Connect your building automation system with wireless Modbus

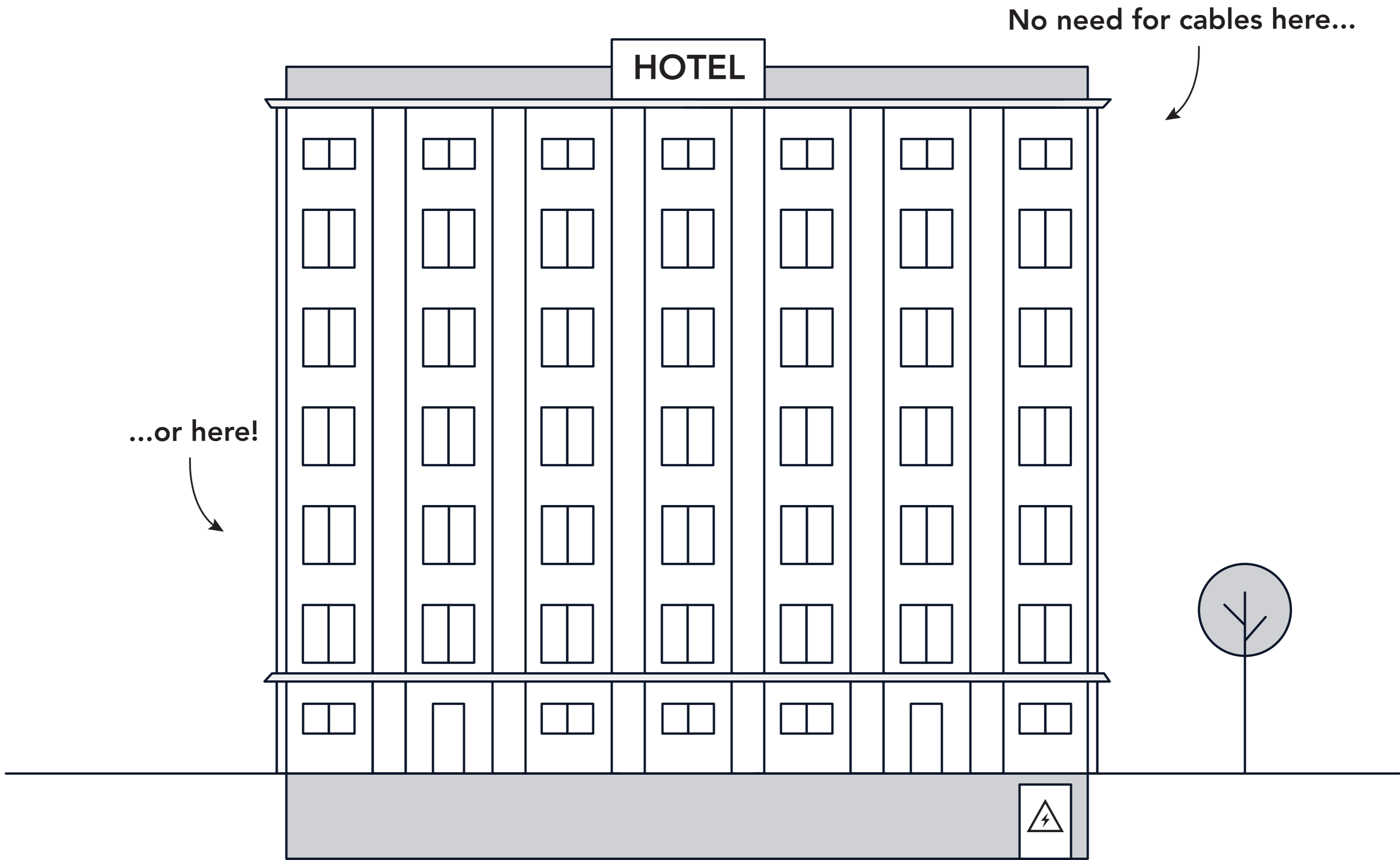



For installation, no Modbus cables are needed.

W-Modbus DIN rail

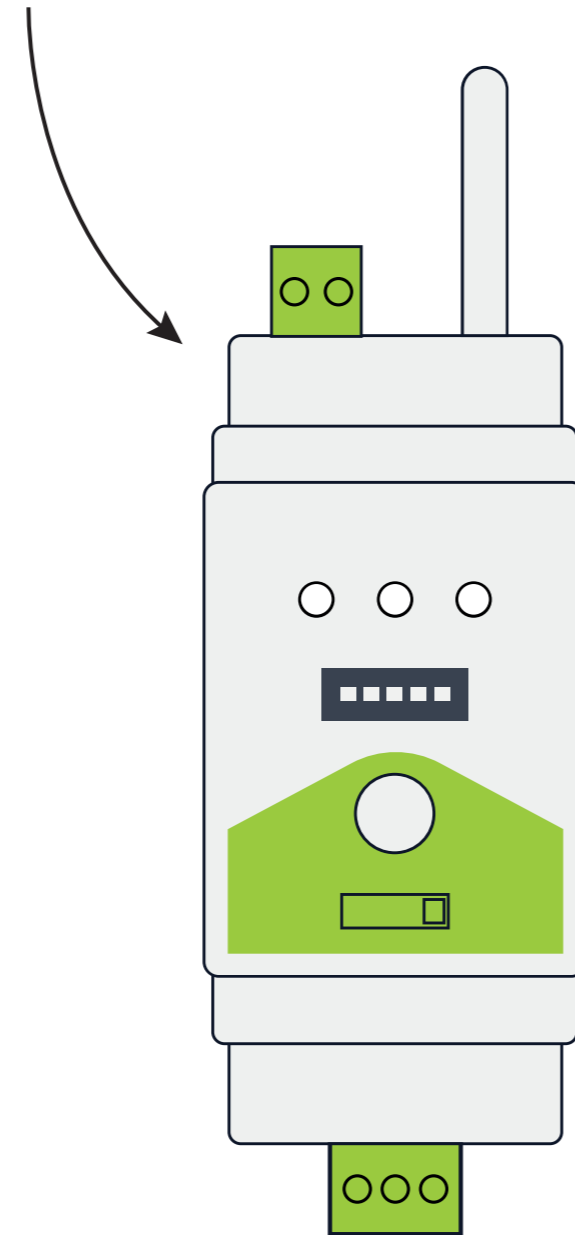

W-Modbus wall mount

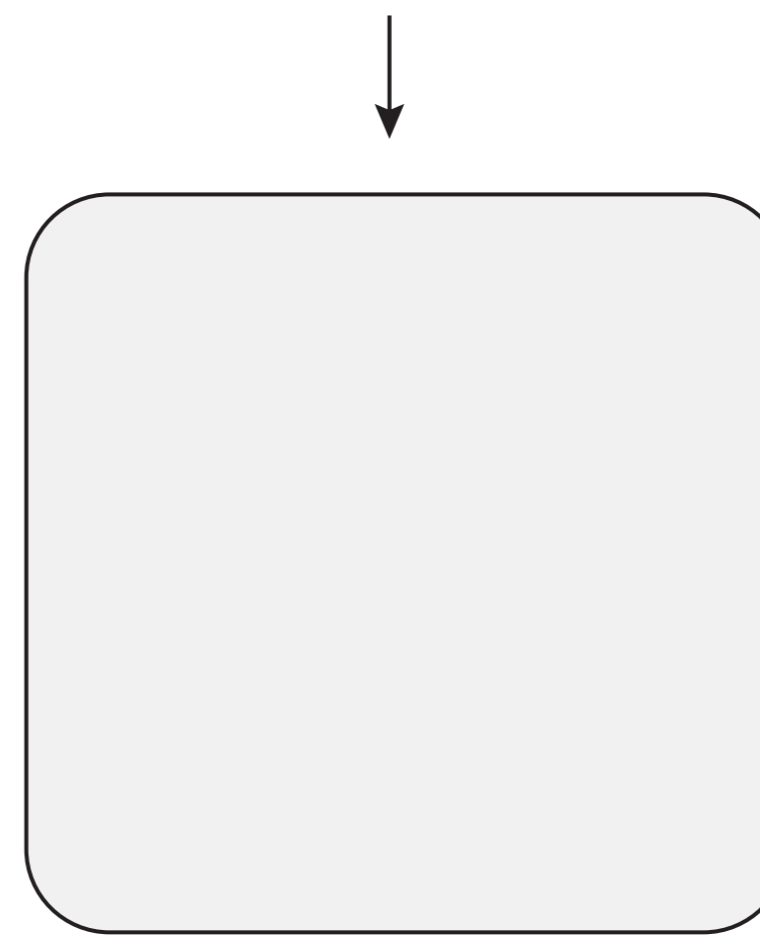

You need this for installation. Choose either W-Modbus DIN rail or W-Modbus wall mount.

A. DIN rail

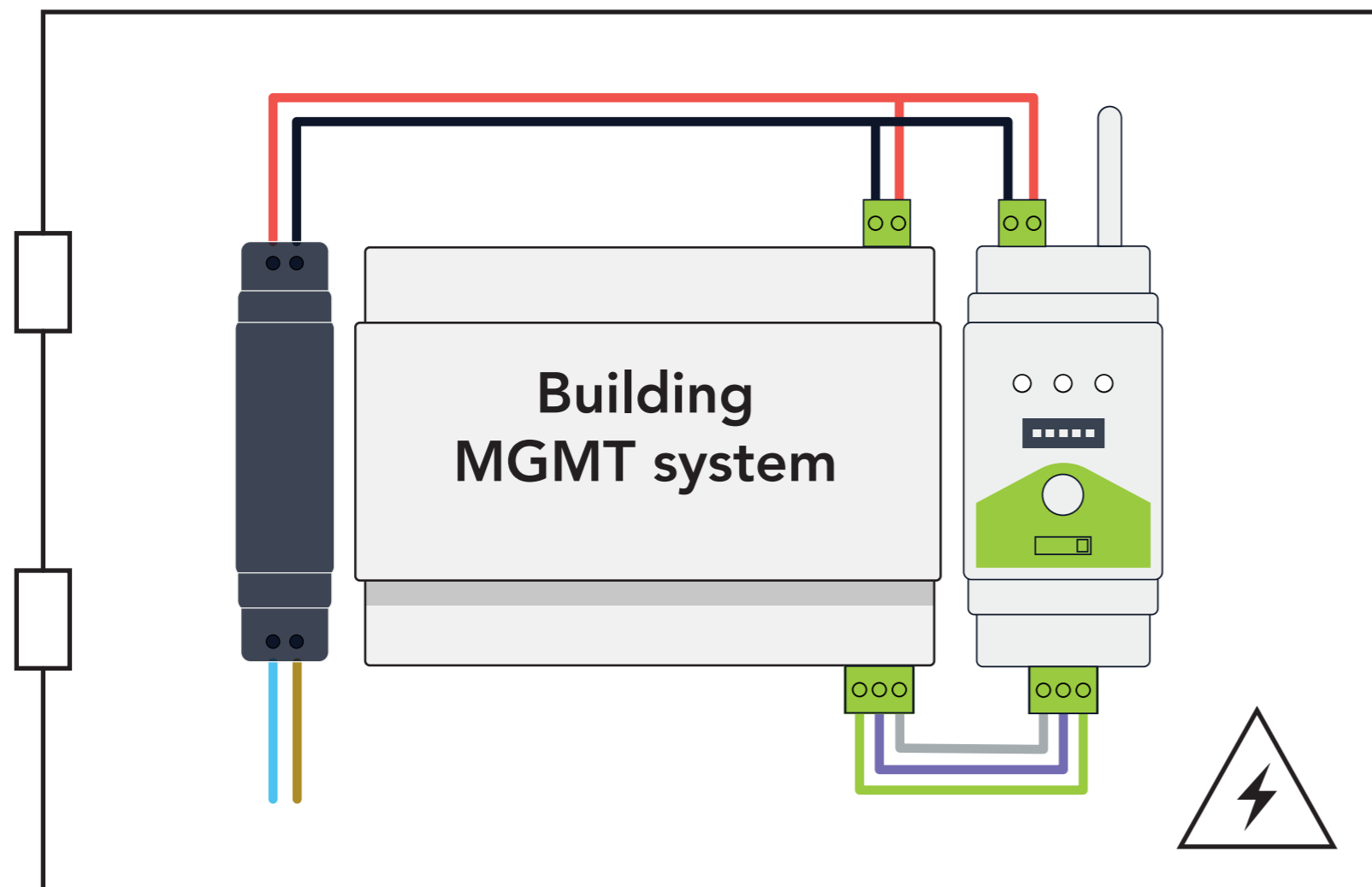

B. wall mount

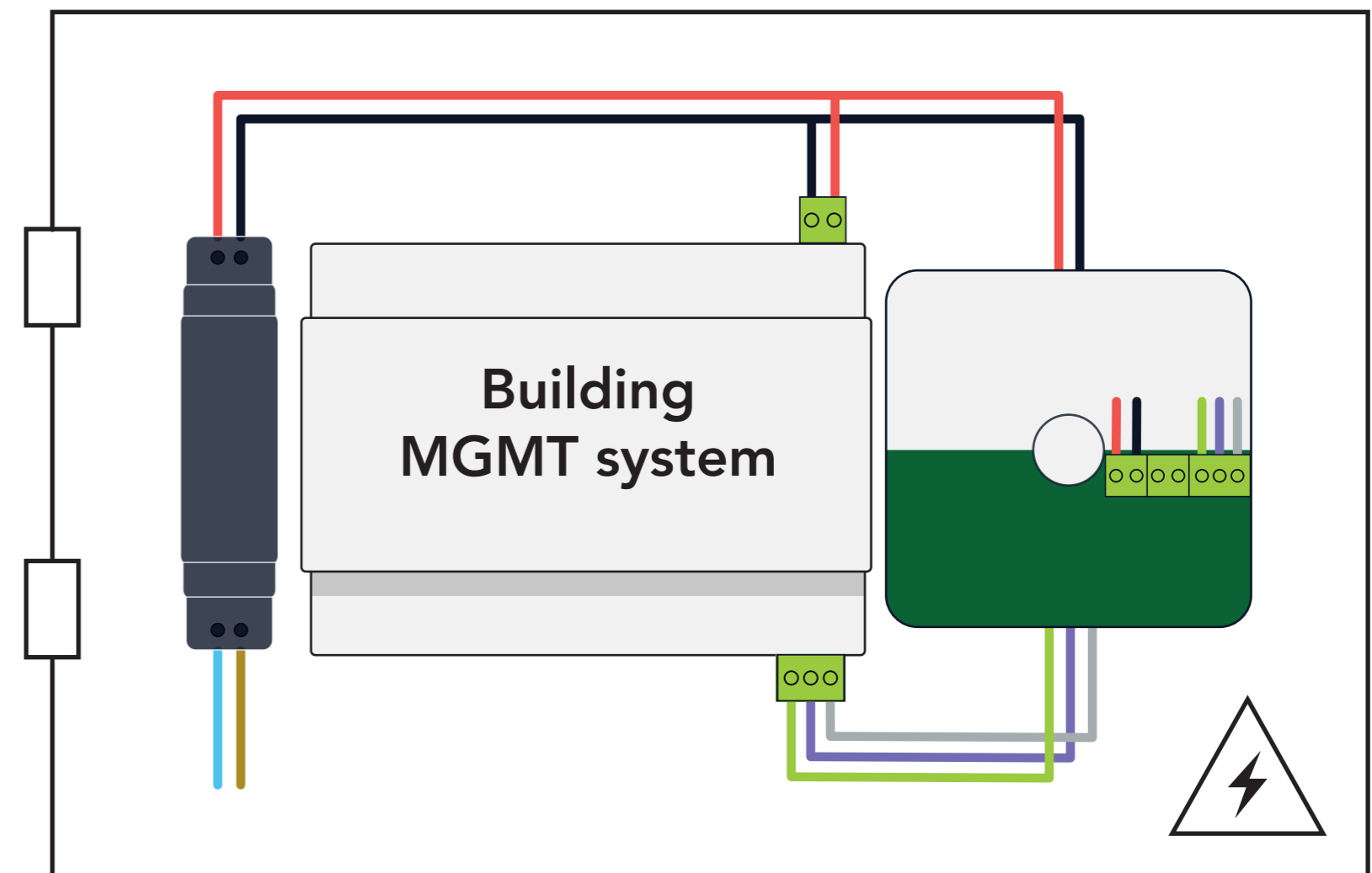

The LumenRadio device next to the Modbus master (client) can serve as your gateway, with both DIN rail and wall mount options available.

GATEWAY SET-UP

A. DIN rail

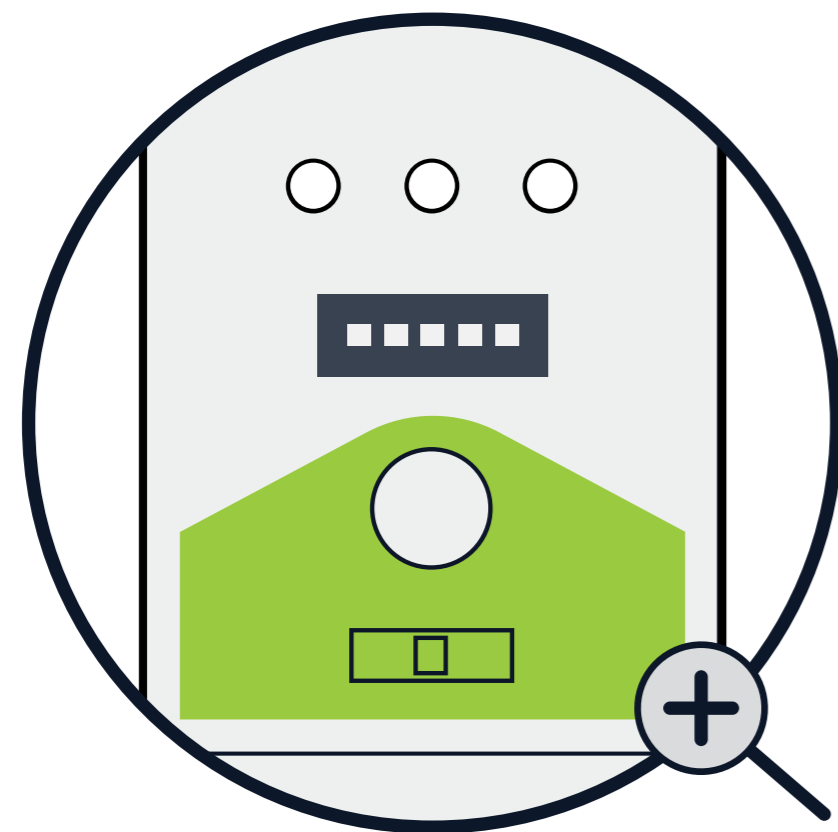

B. wall mount

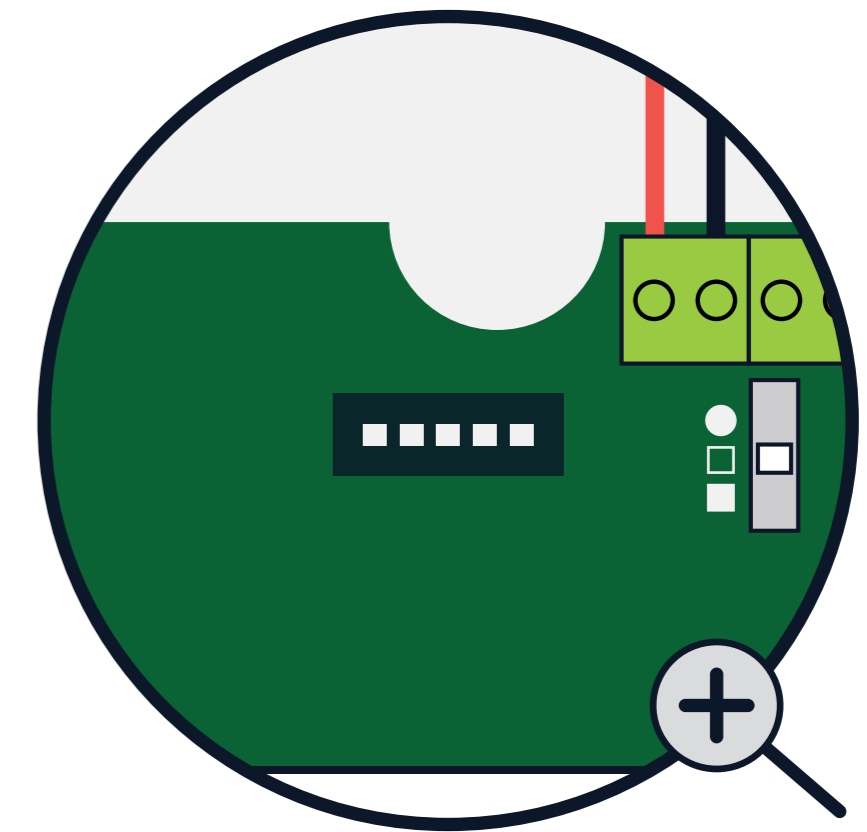

	1	2	3	4	5
9600 baud	OFF	OFF	-	-	-
19200 baud	OFF	ON	-	-	-
38400 baud	ON	OFF	-	-	-
76800 baud	ON	ON	-	-	-
No parity	-	-	OFF	-	-
Even parity	-	-	ON	-	-
1 stop bit	-	-	-	OFF	-
2 stop bit	-	-	-	ON	-
Use local serial configuration set on Node					ON
Use Gateway serial configuration on Node					OFF



Set your Baud rate, stop bit and parity on the gateway (A or B).

A. DIN rail

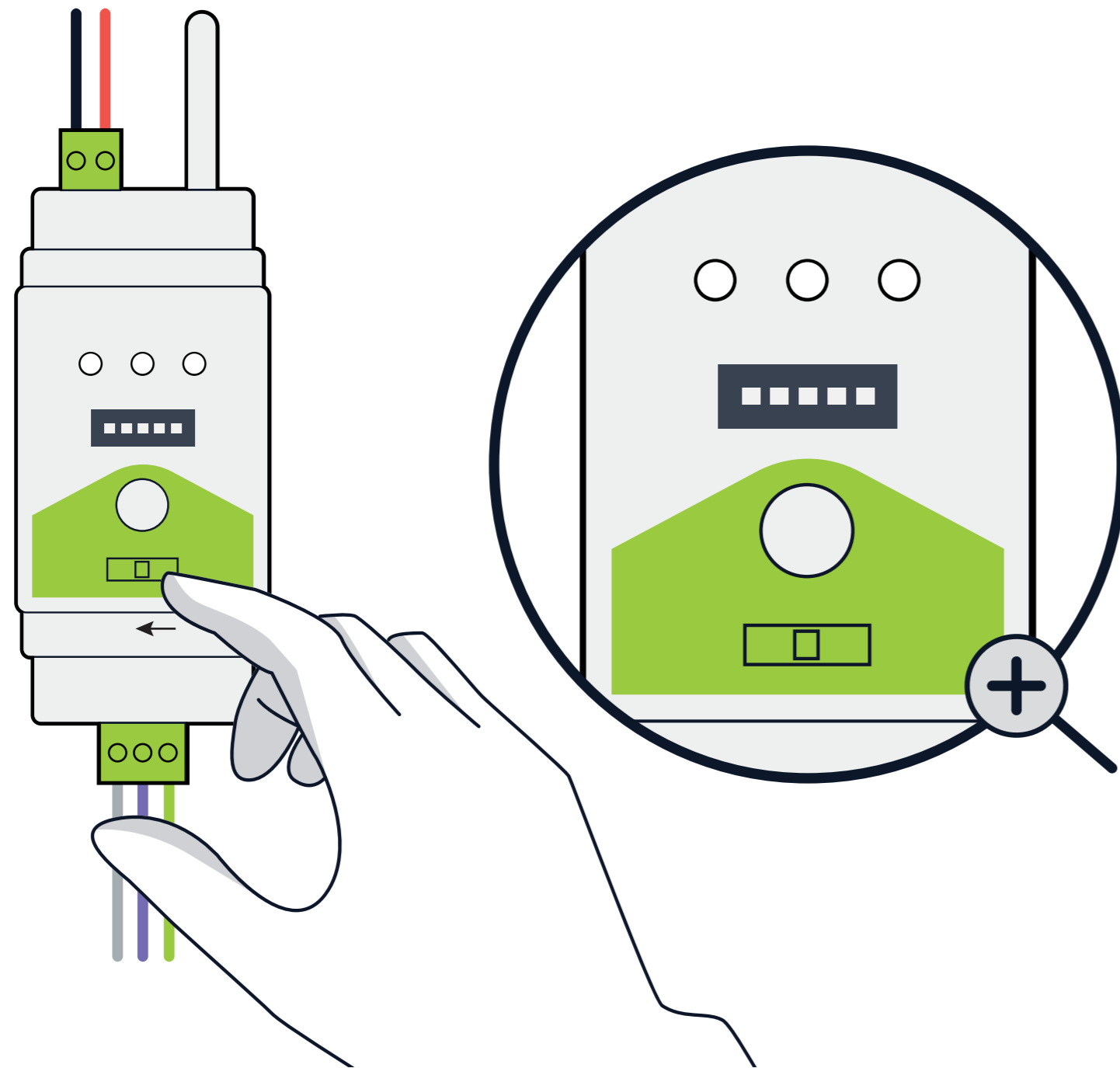

B. wall mount

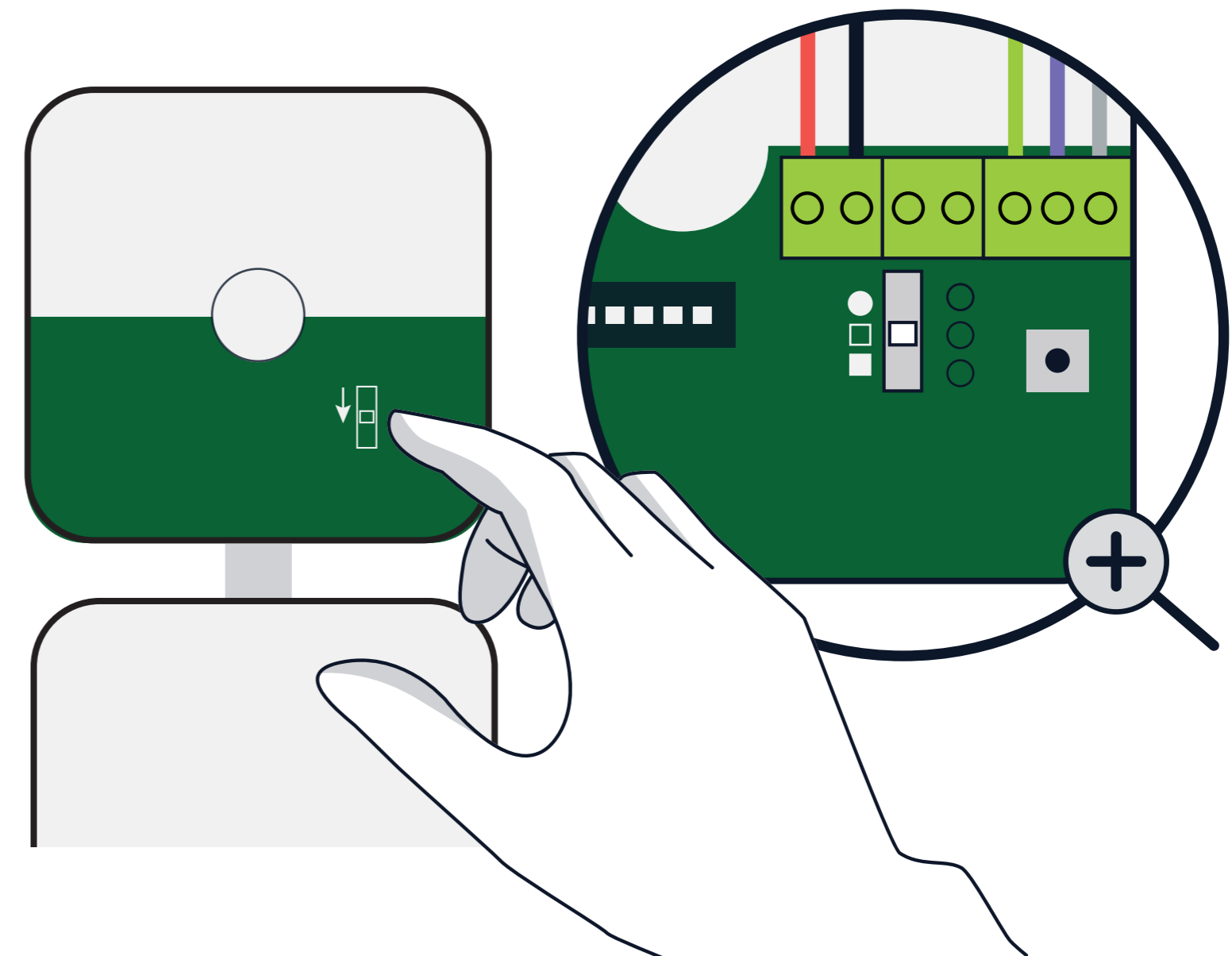

A - Move the switch to "COMM" or B - Move the switch to "".
Continue by installing the LumenRadio node next to your field devices, starting with the one closest to your gateway.

Ex. Node to zone controller

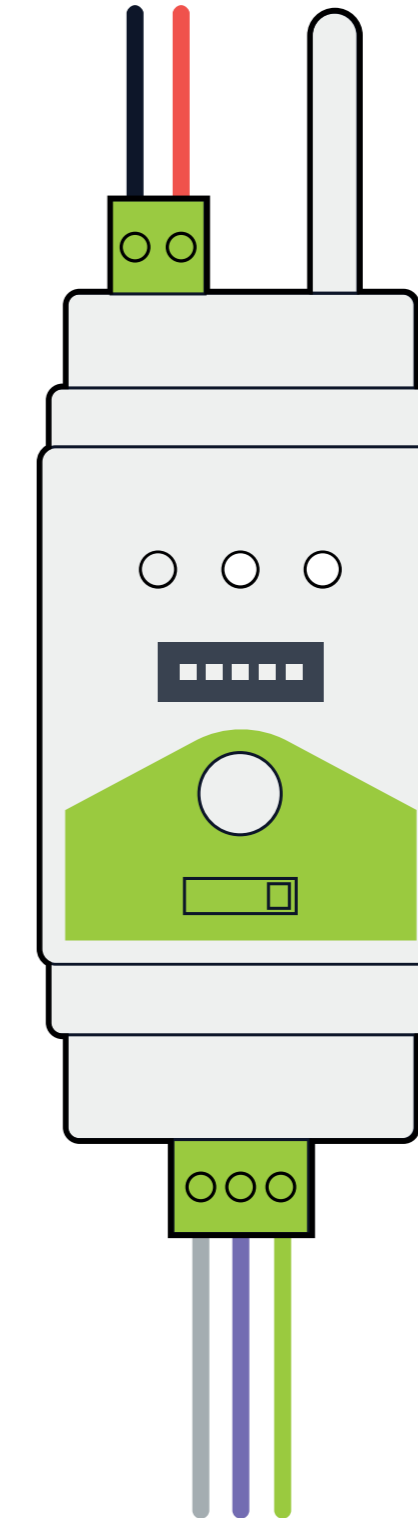
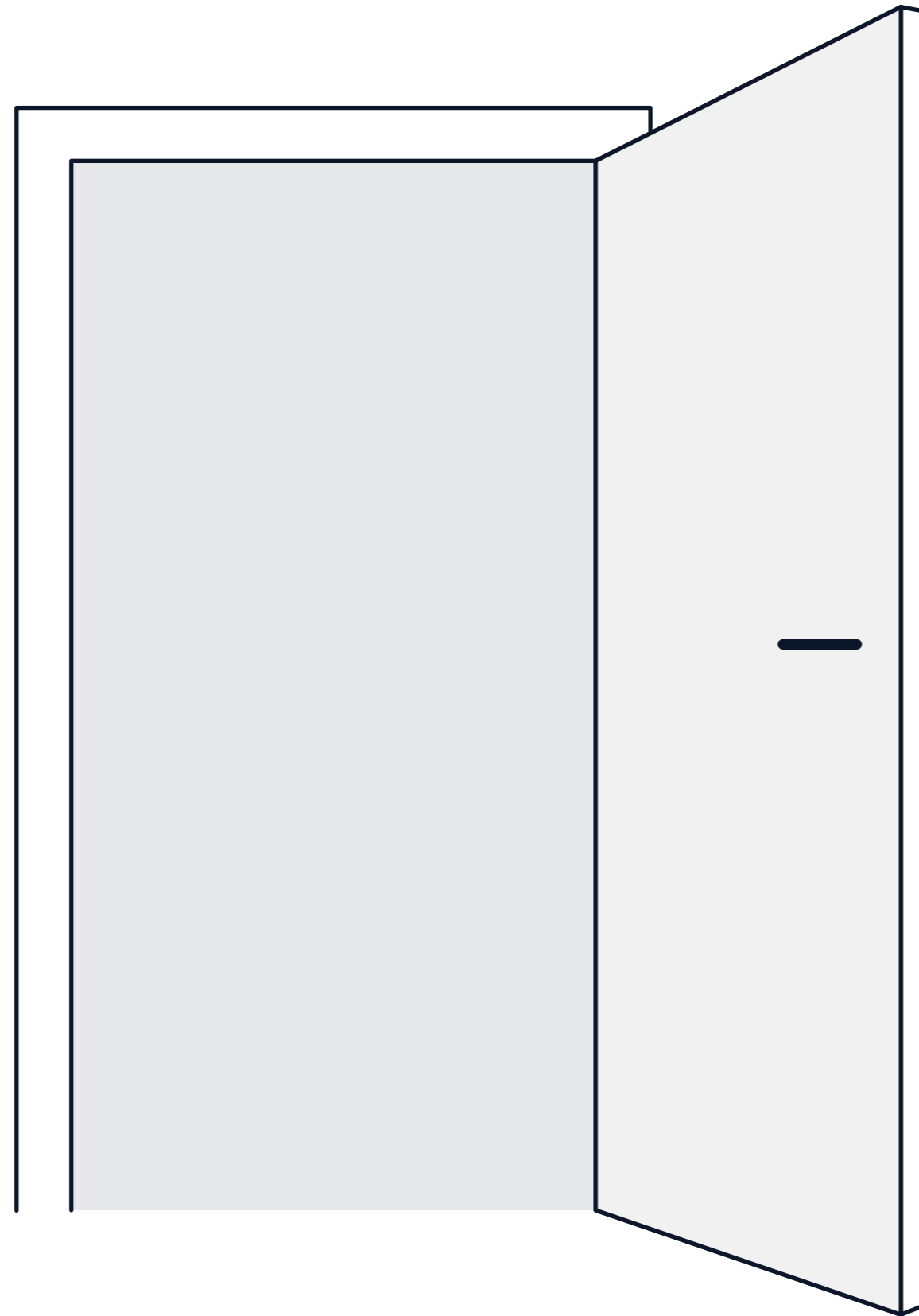
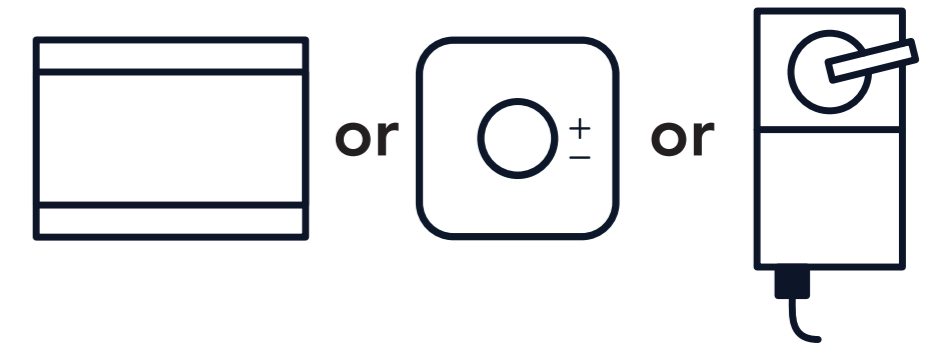

Connect the LumenRadio device with chosen device (zone controller). Optionally, set a local Baud rate.

Ex. Node to room controller

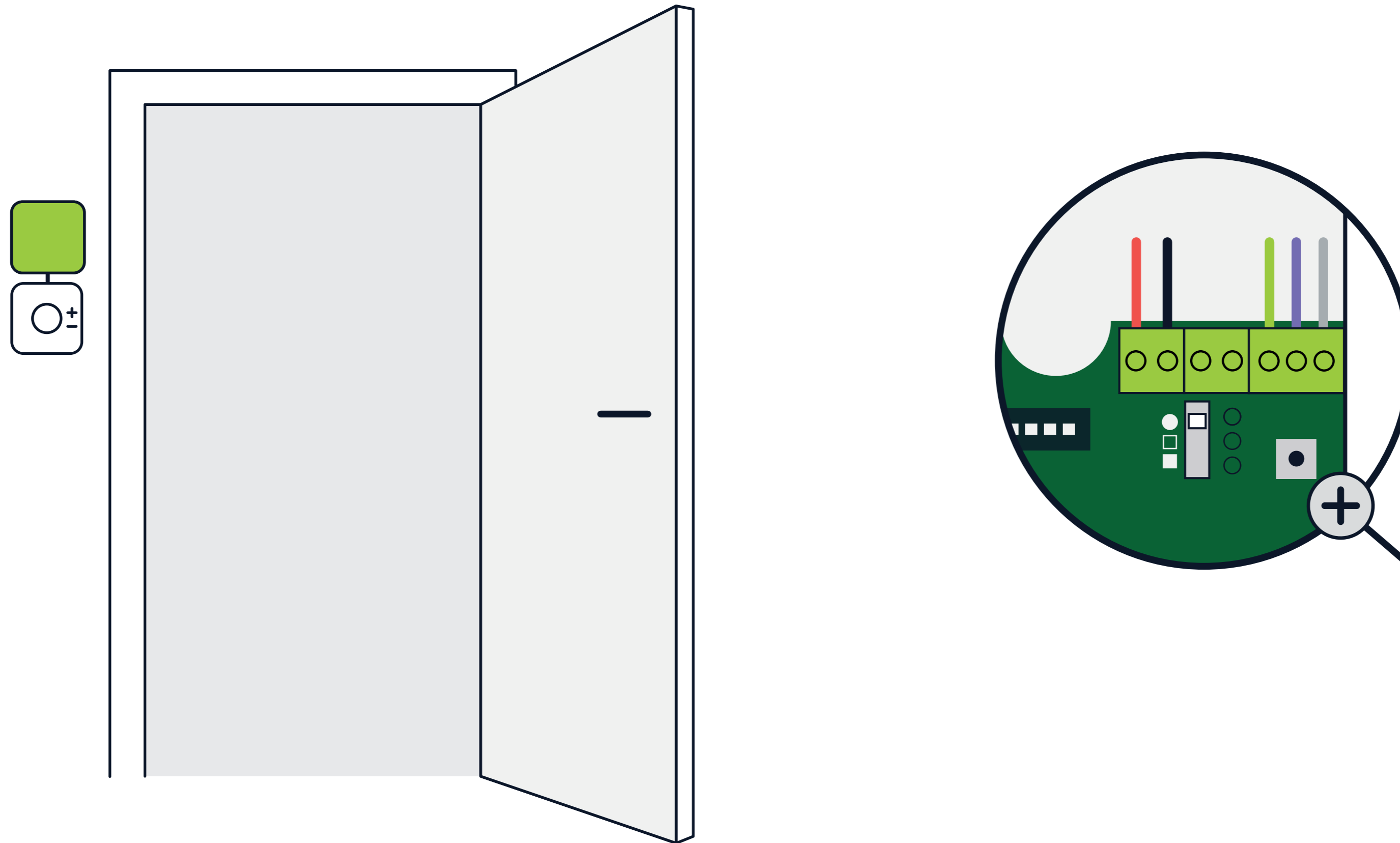
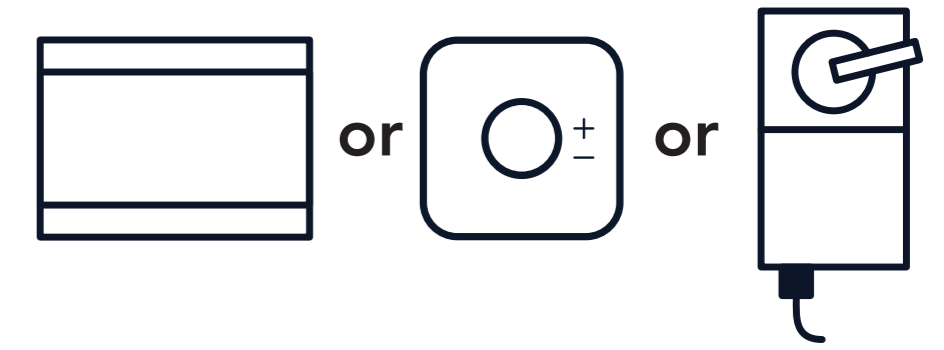

Place the LumenRadio device preferably above the chosen device (room controller) and connect. Optionally, set a local Baud rate.

A. DIN rail

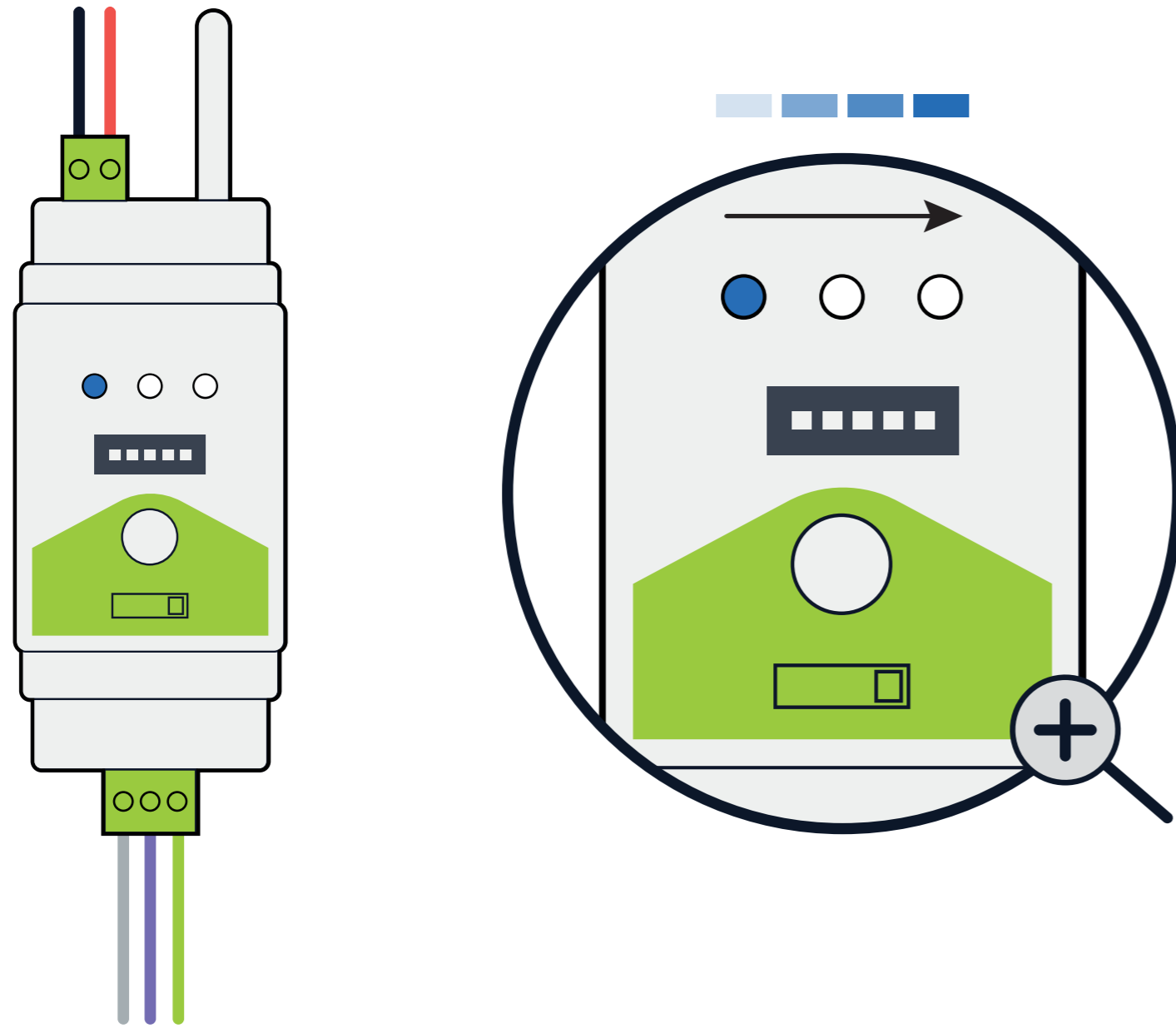

B. wall mount

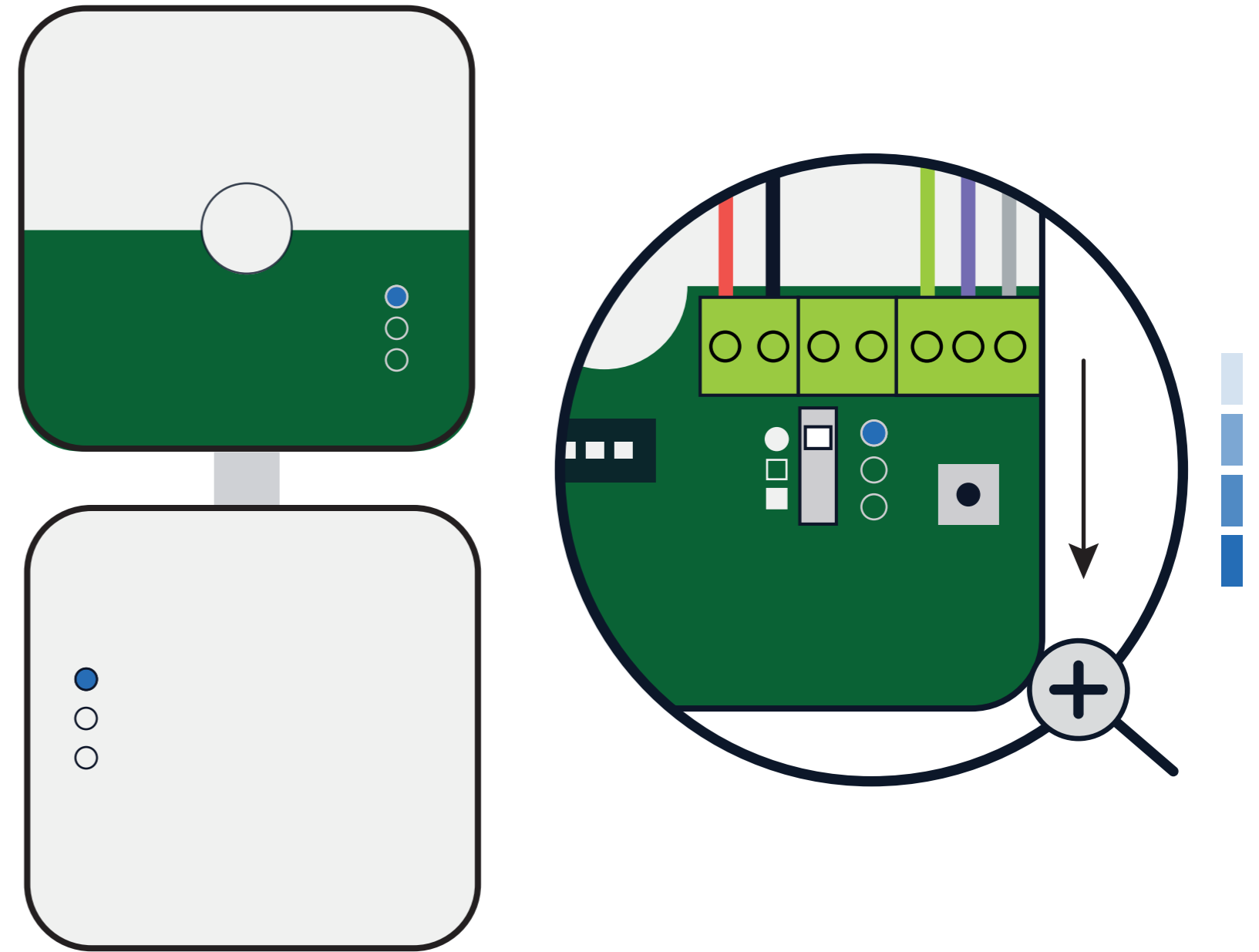

The lights on your node will now sweep in blue.

A. DIN rail

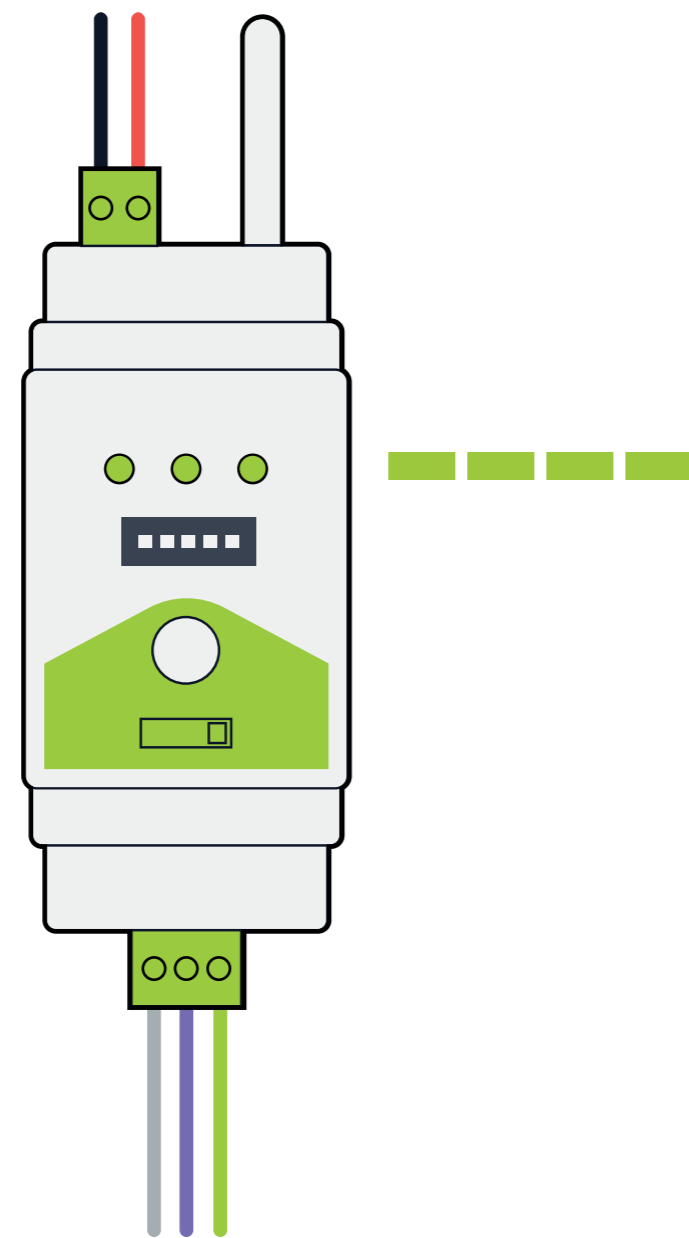

B. wall mount

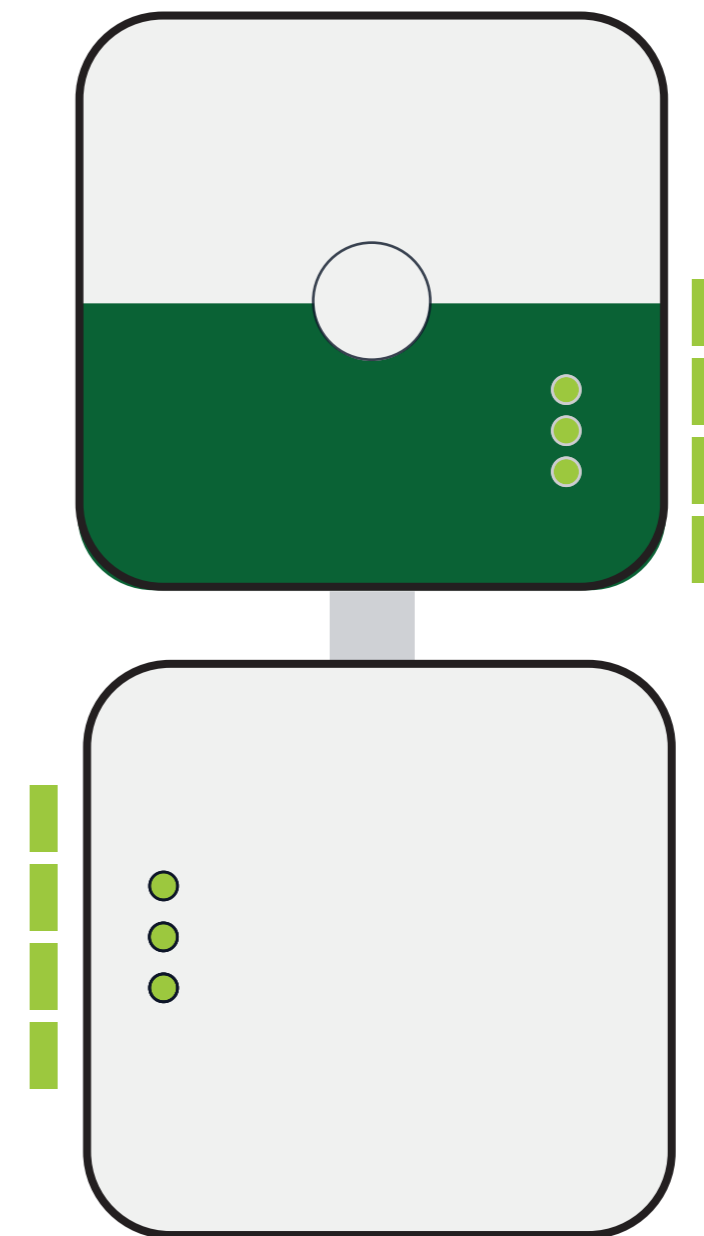

When the lights start blinking green, the node has found the gateway. This can take up to five minutes.

A. DIN rail

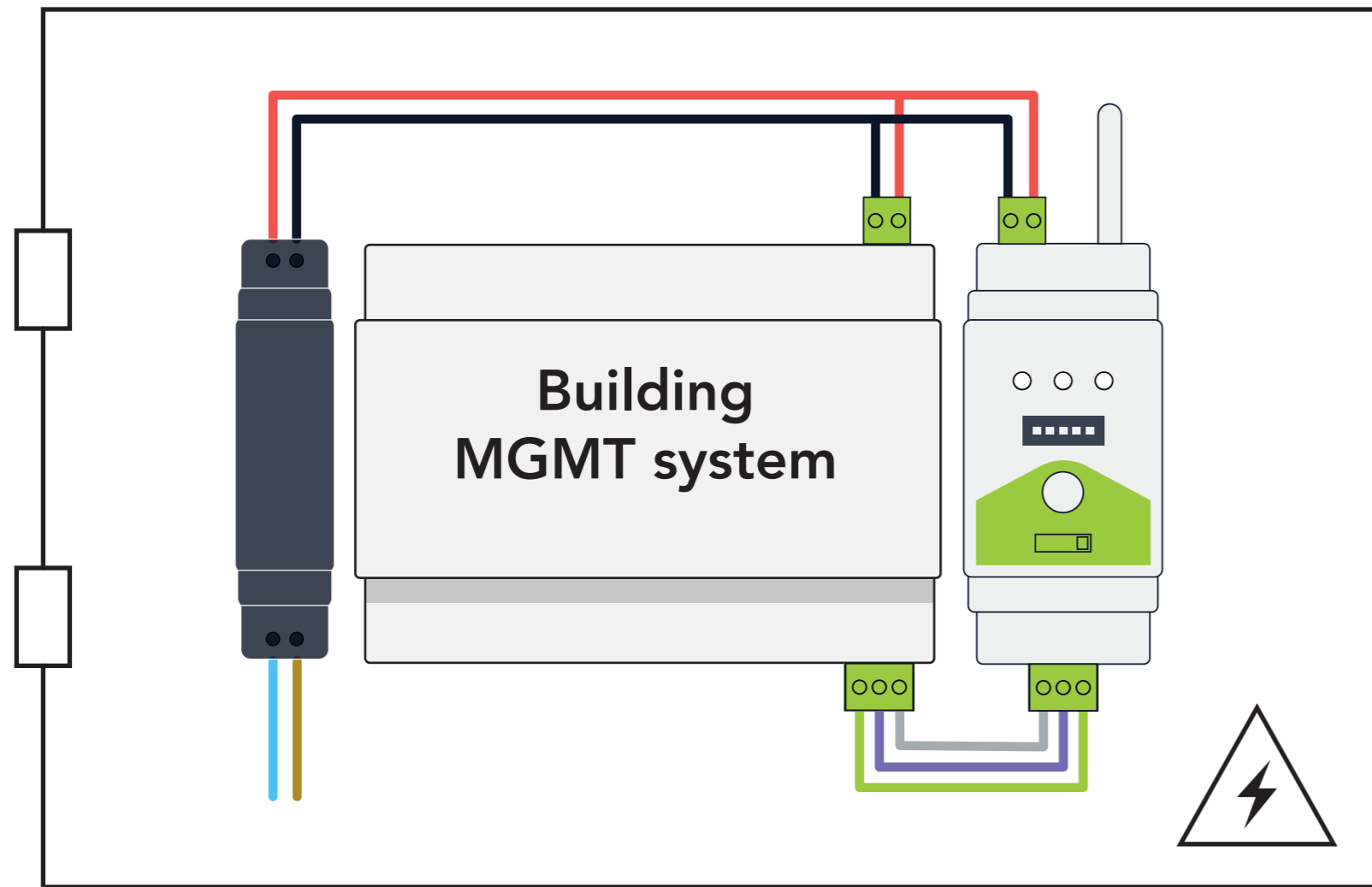

B. wall mount

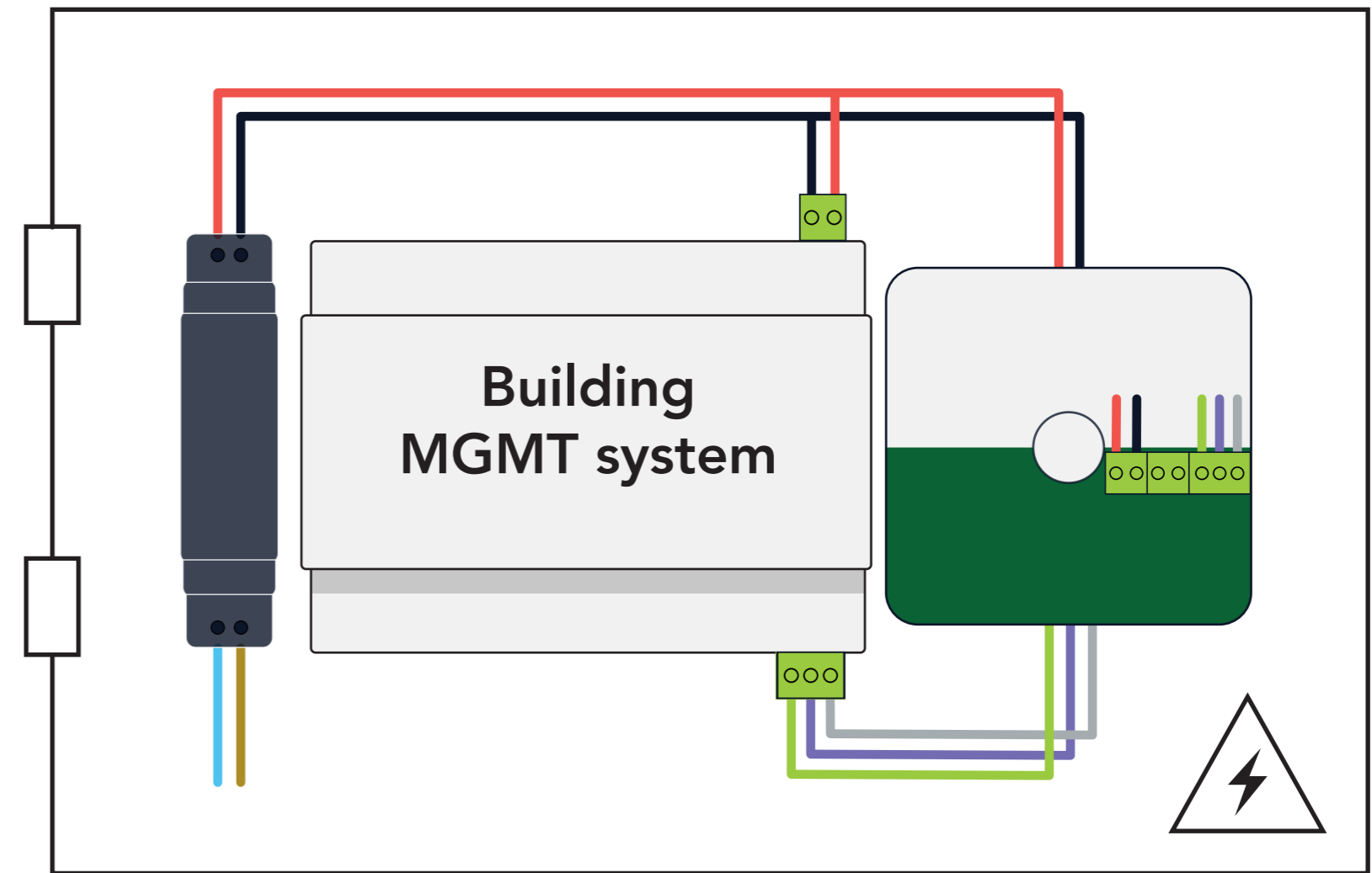

Go back to the gateway.

A. DIN rail

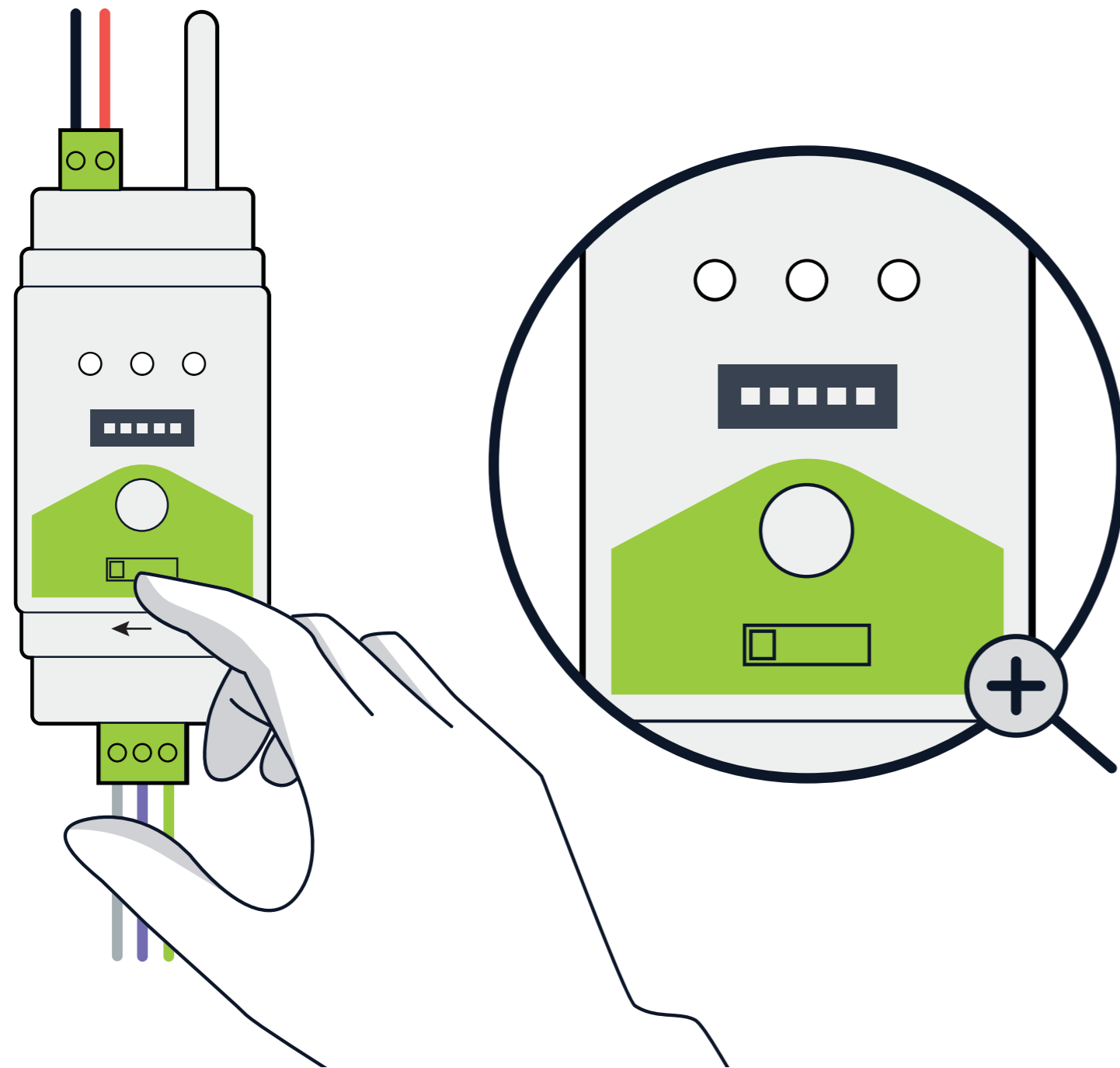

B. wall mount

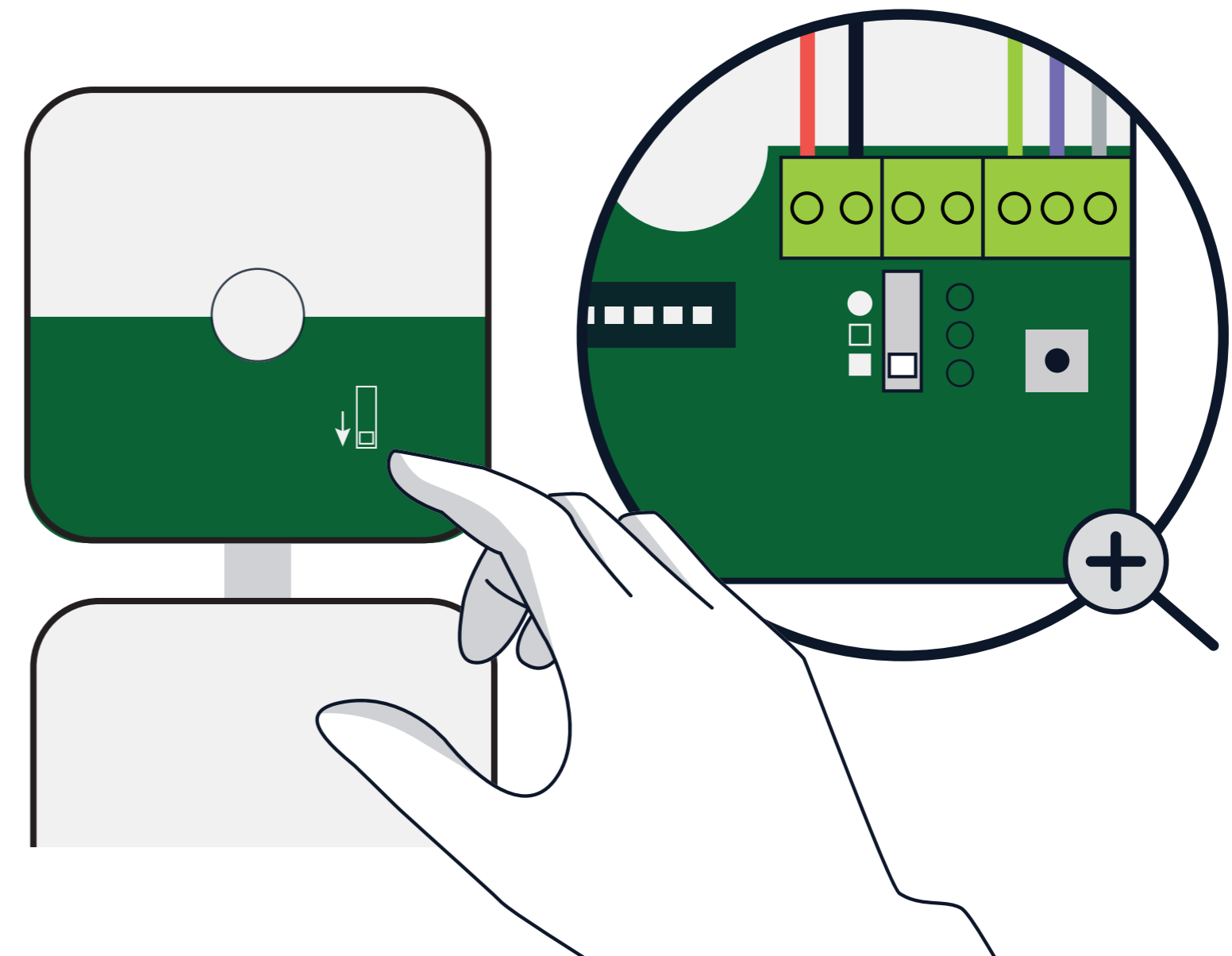

**A - Move the switch to "GATEWAY"
or B - Move the switch to "□"**

A. DIN rail

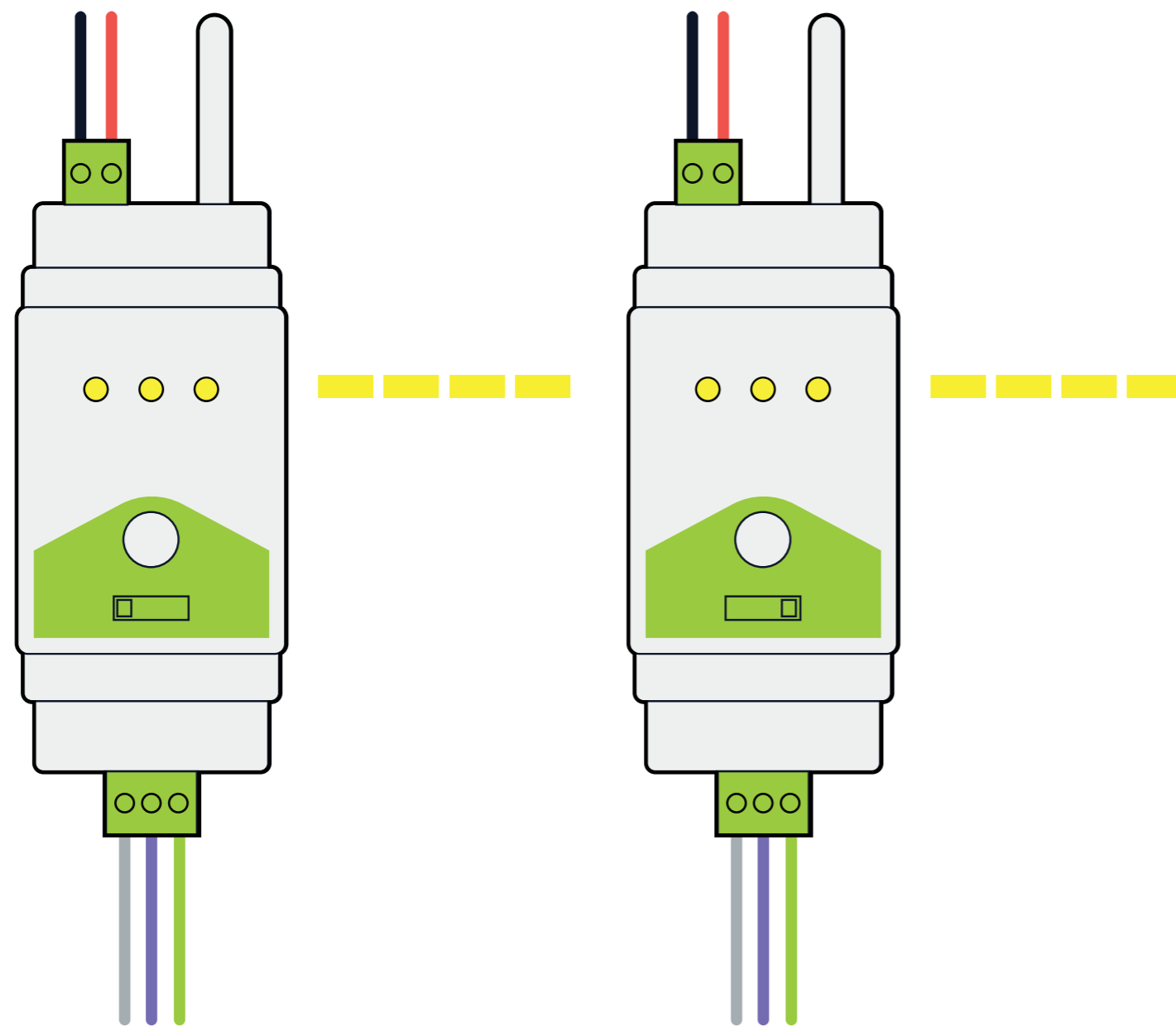

B. wall mount

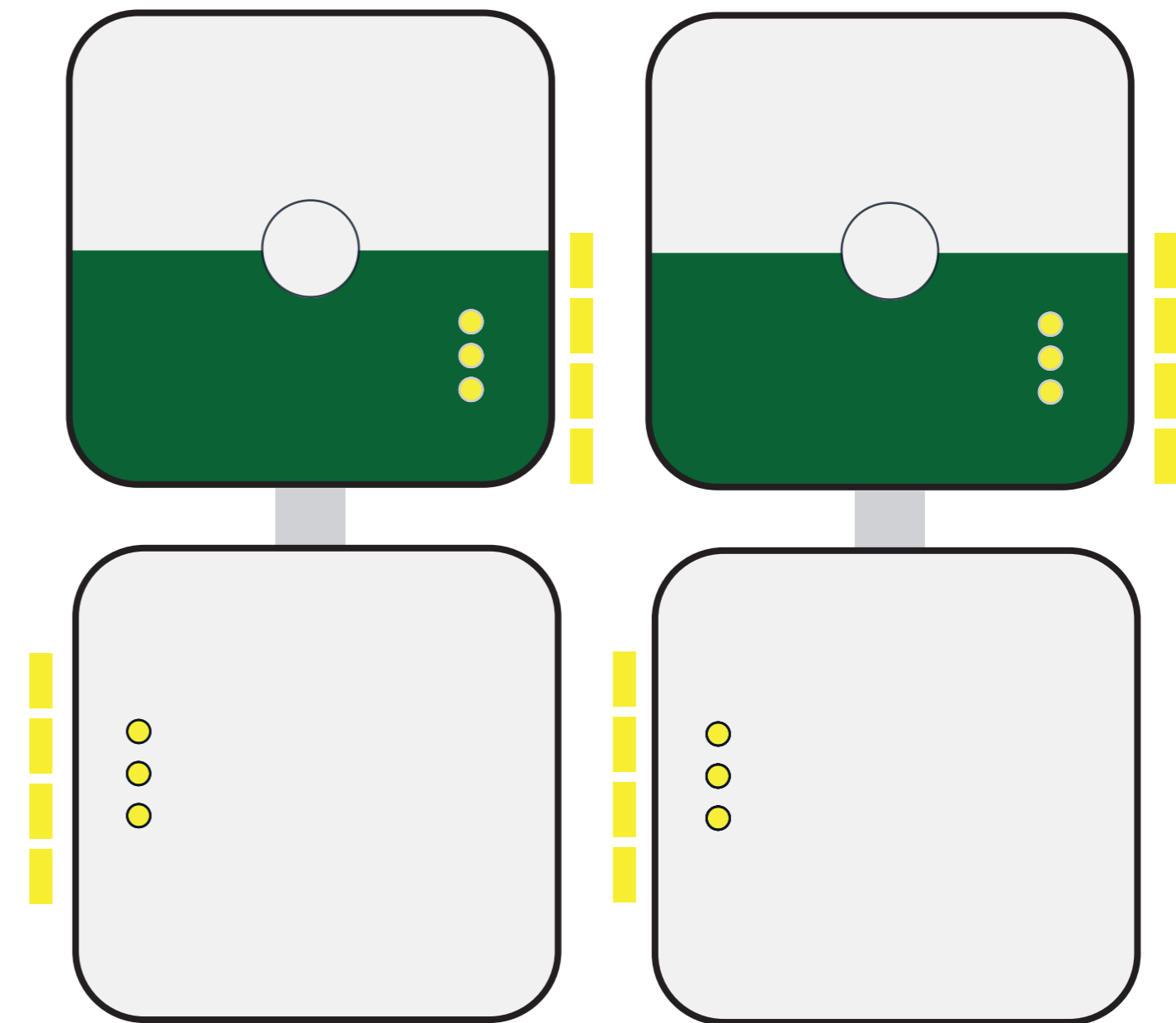

**The devices blink yellow entering secure mode.
This may take up to 5 minutes.**

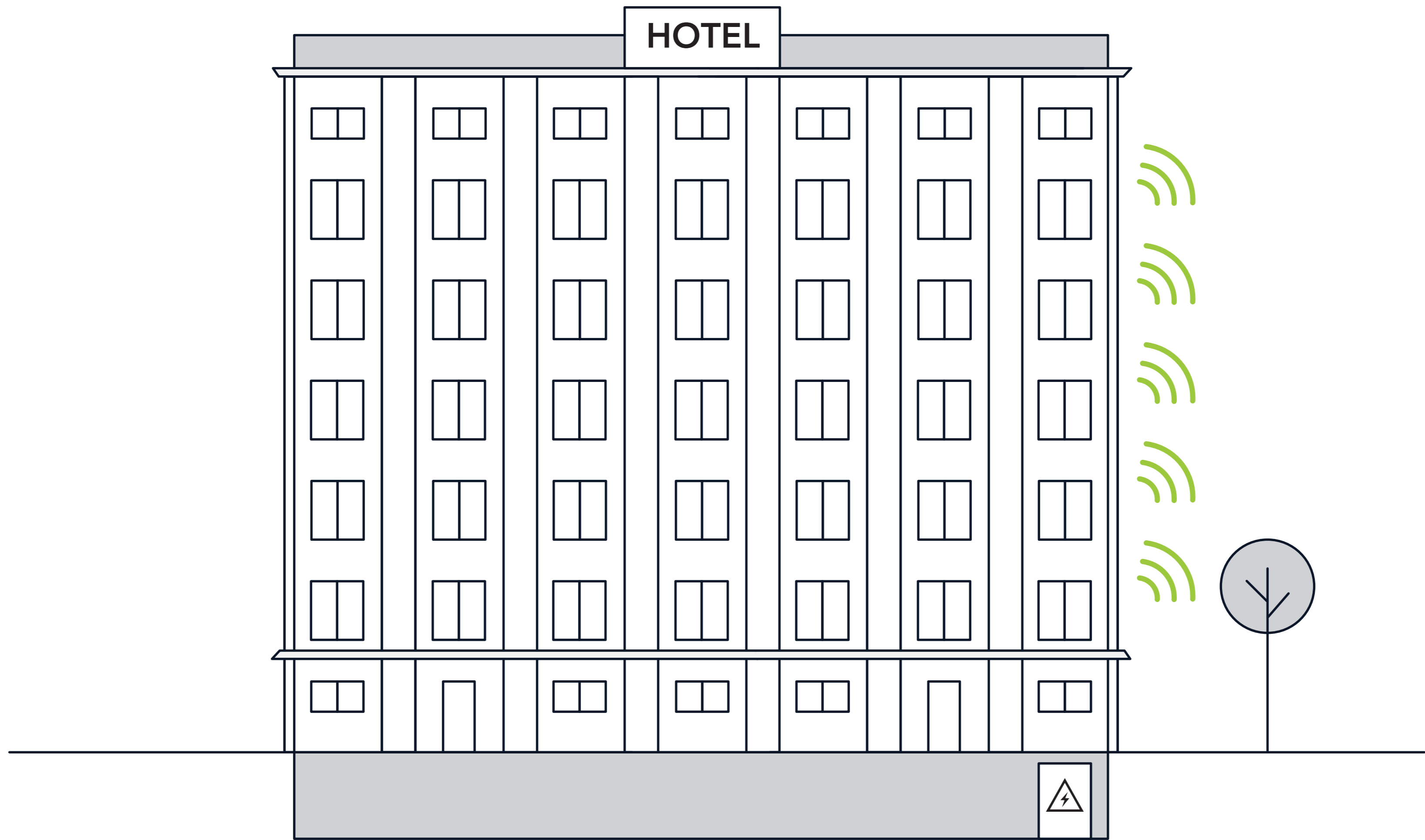

Now you have a wireless connection!

A. DIN rail

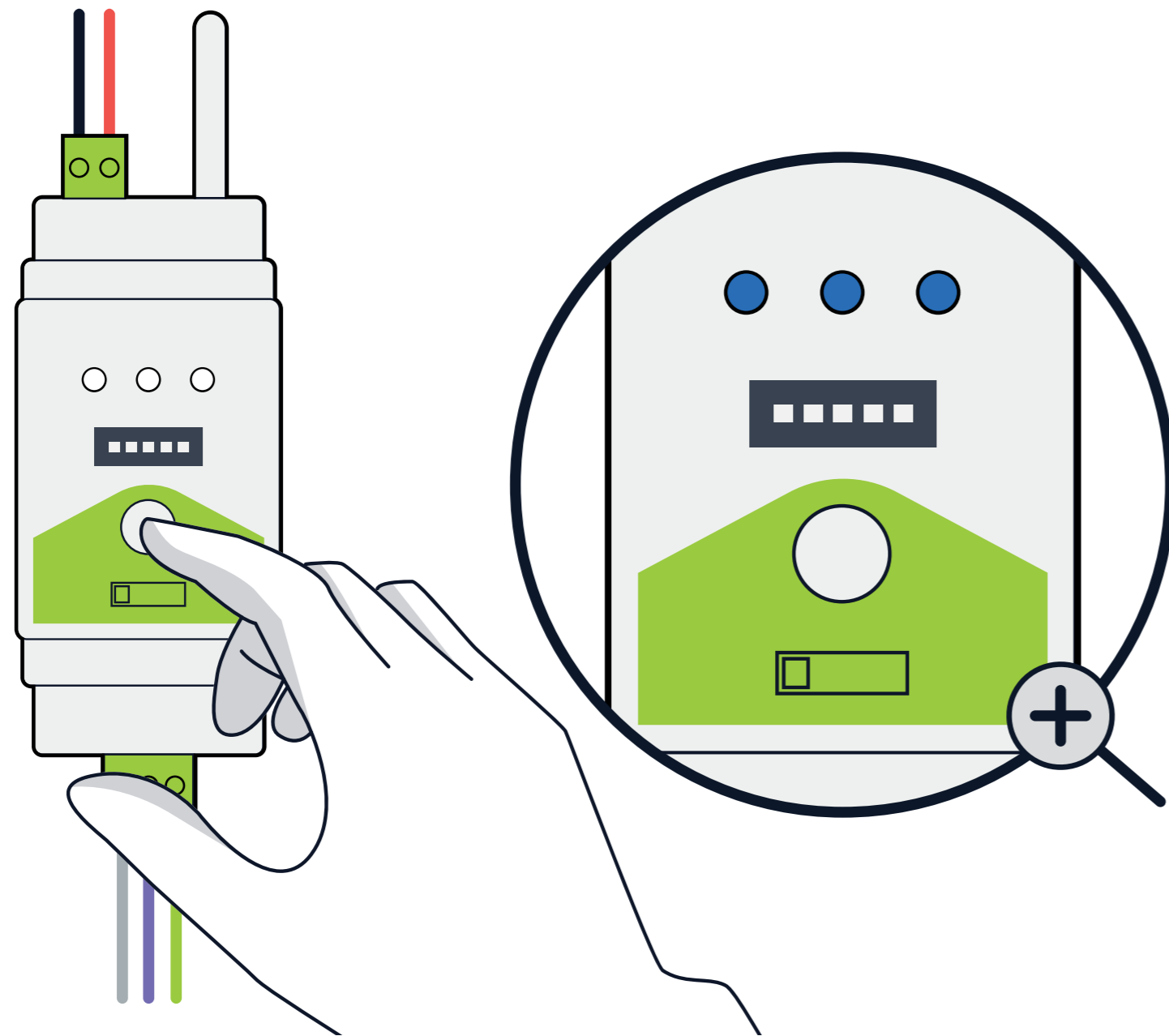

B. wall mount

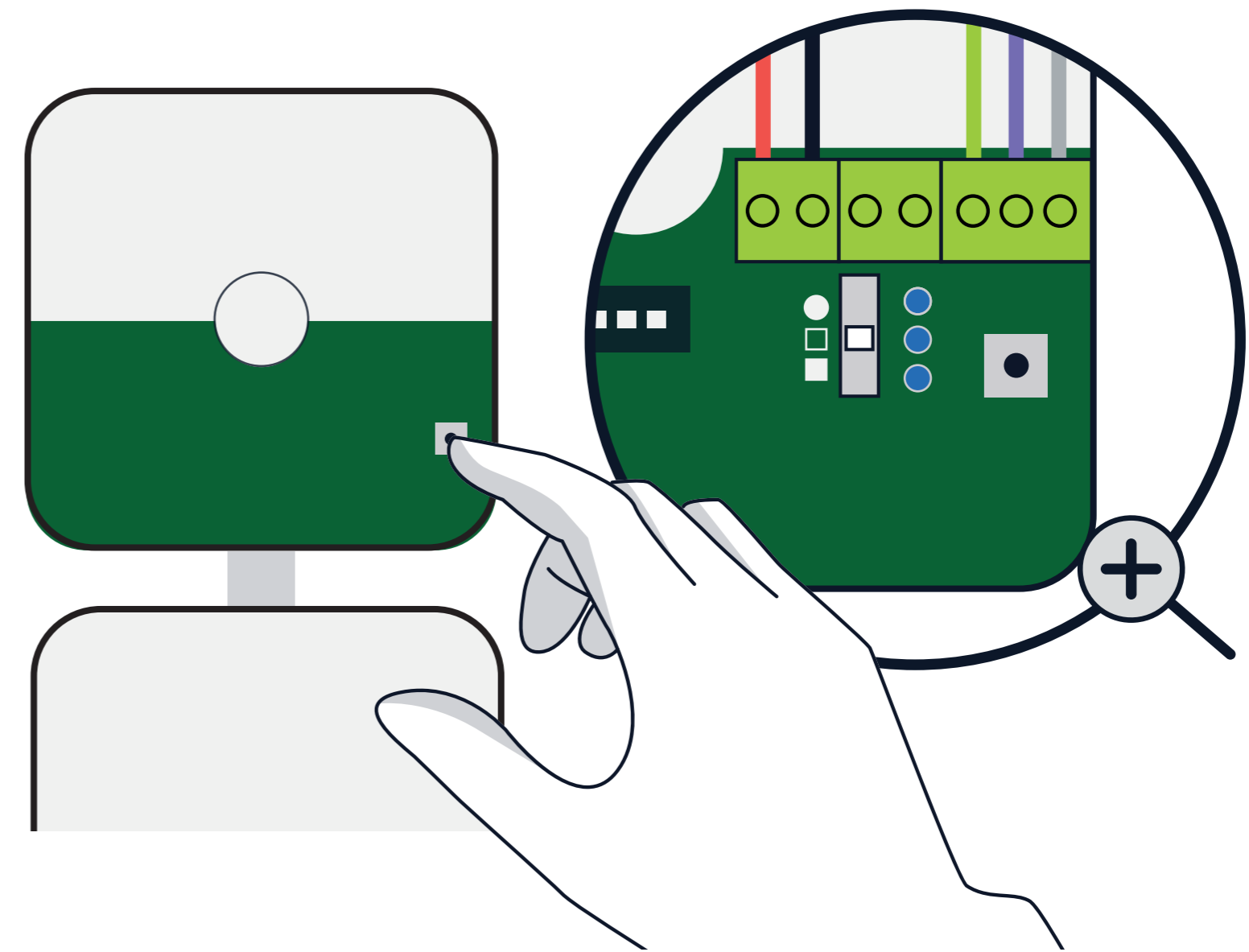

To use the W-Modbus app, press the button on the gateway three times so that it blinks blue twice and you are ready to connect.

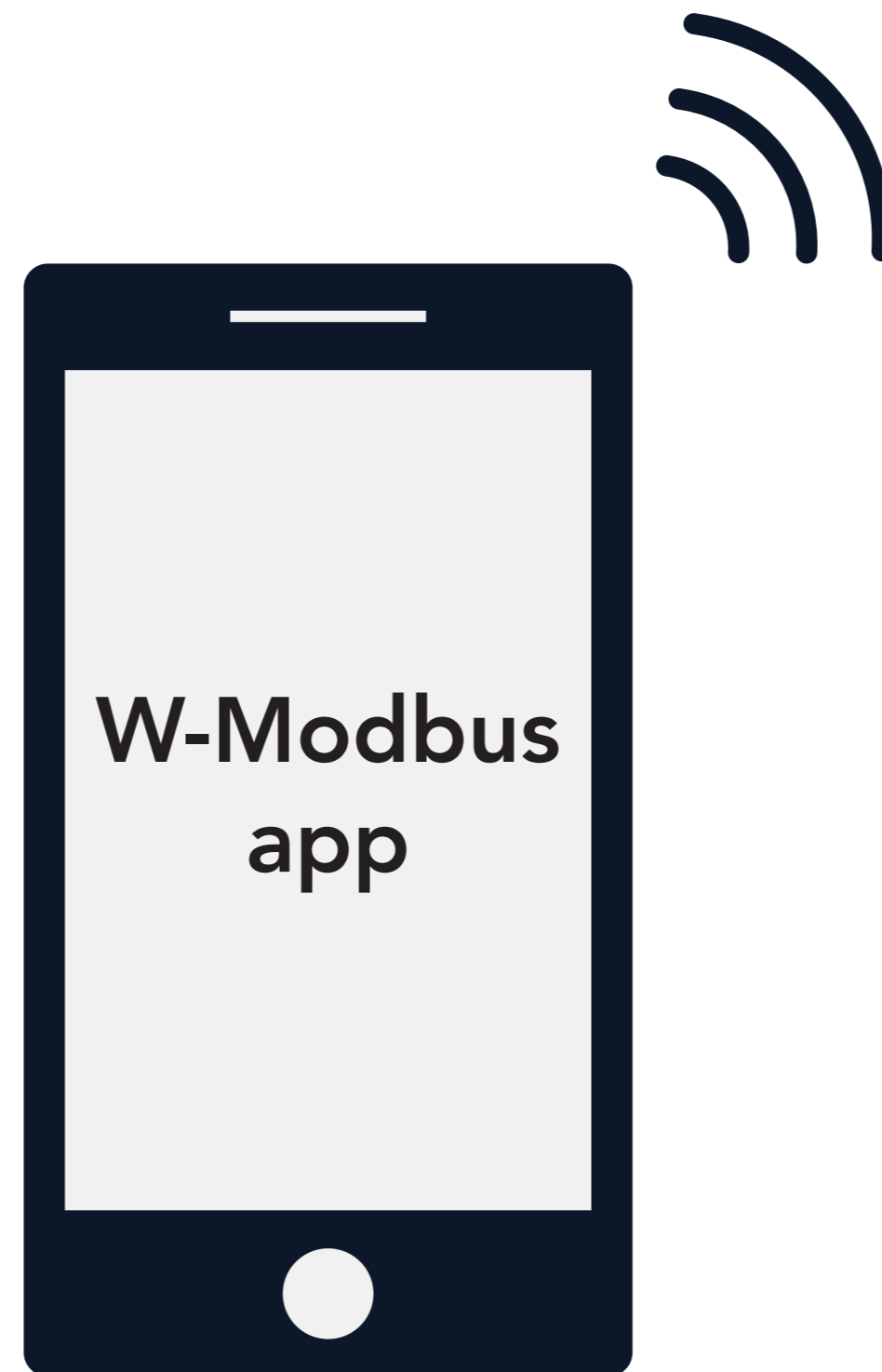

**Verify your installation in the app.
For a detailed overview, select Network Map.**



Learn more at www.lumenradio.com